

# **MINIFIBERS, INC.**

## **The Craft of Cutting Fiber**

This paper was written by G.B. Keith, founder of MiniFibers, and presented at the TAPPI Nonwoven Fibers Seminar in 1979. It still contains a great deal of information which is useful today.

### **ABSTRACT**

The art of cutting fiber has not been pursued with the diligence it deserves. It is presently in a state of neglect. Other components of the total nonwovens entity are further advanced. Intense development of the cutting art, bringing with it quality raw materials, will be responsible for the greatest upsurge yet in the growth of the nonwovens industry.

“O what a tangled web we weave when first we practice to deceive.”  
- Sir Walter Scott

The webmaker who believes he can produce quality web using poorly cut fibers has just begun to “practice to deceive” – to deceive his customers, the stockholders, and himself!

### **THE ELUSIVE FILAMENT**

There is probably no task so singularly demanding as the accurate cutting of a truckload of short cut, nonwoven fiber. The purchase order could read: “One and one-half trillion pieces of polyester, each one-half thousandth of an inch in diameter, one-fourth inch long, square cut ends, cut from drawn filaments, relaxed and heat set, no longs and no fusing!” No finish is specified; that’s another story. Why complicate the issue with a chemical handicap?

By way of comparison, let us inspect a spoonful of white sugar with the naked eye. One is readily quite certain that the particle size varies by a factor of 10 to 1. It doesn’t matter; your cup of coffee will never know the difference. However, a single filament 10 times normal length, mixed with the above one-fourth inch fibers, will produce a defect in a nonwoven web so immediately discernible that it can be detected by the naked eye, even if the web is traveling at a speed of 1,000 feet per minute!

Justifiably, it somewhat naturally follows that while no task is so singularly demanding as cutting fiber, no task is so singularly rewarding or valuable. The webmaker requires fiber with at least no extreme longs or fused filaments. He demands it and is willing to pay the price. To do otherwise exacts an economic judgment too severe to contemplate. Stockholders know it as “going out of business!”

## WHAT IS A POOR CUT?

Though cutting fiber may not be an exacting science, poorly cut fiber is easy to describe: It may be too long or too short, have a faulty end condition, or both.

### Longs

Filaments which are too long lasso other fibers, gather together concentrations and entanglements which will not satisfactorily pass between downstream calendaring rolls. These clumps form web defects described as dumbbells. Dumbbells occur when both ends of a long fiber lasso other fibers. Such a formation is shown in Figure 1.

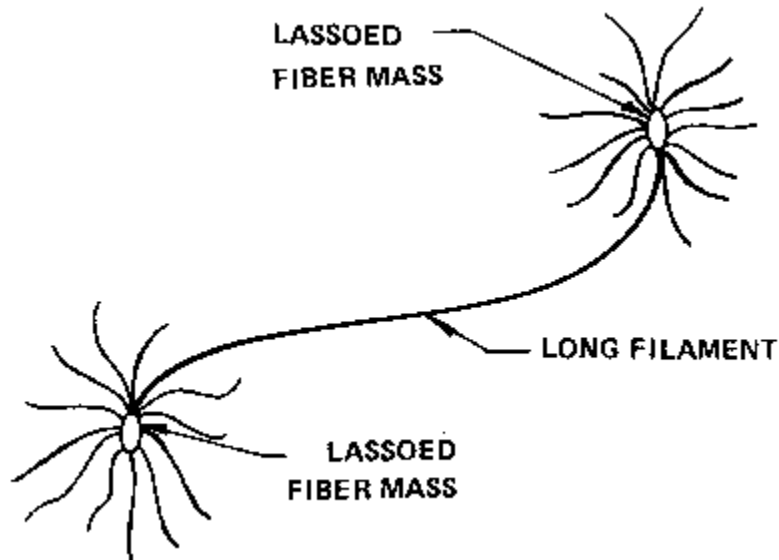

Figure 1

Should only one end of a long filament lasso other shorter fibers, web defects known as scabs are produced. Such a defect is shown in Figure 2.

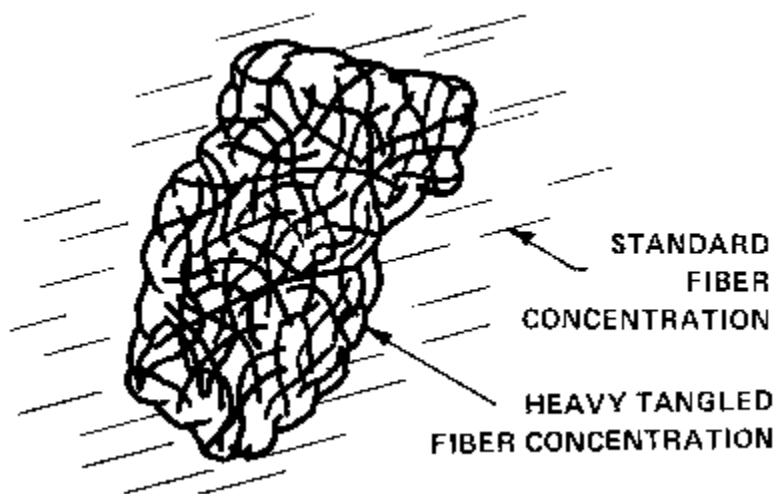

Figure 2

Sometimes a concentration of fiber is so bulky that it will not pass between the rolls without splitting down the middle. These defects are called blisters. Such a defect is shown in Figure 3.

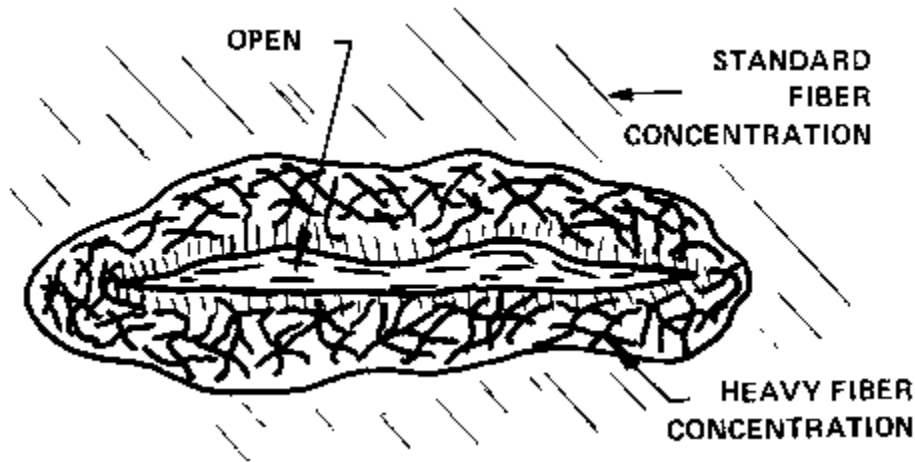

Figure 3

### Shorts

Little need be said about fibers which are too short. Other than their failure to carry a proportionate share of the load as tension members in the web, they cause no concern. They lay well, do not concentrate or entangle, and pose no other manufacturing problem. They only loaf on the job.

### End Conditions

The ideal end condition is a smooth, square cut. Such an end, highly magnified, is shown in Figure 4.

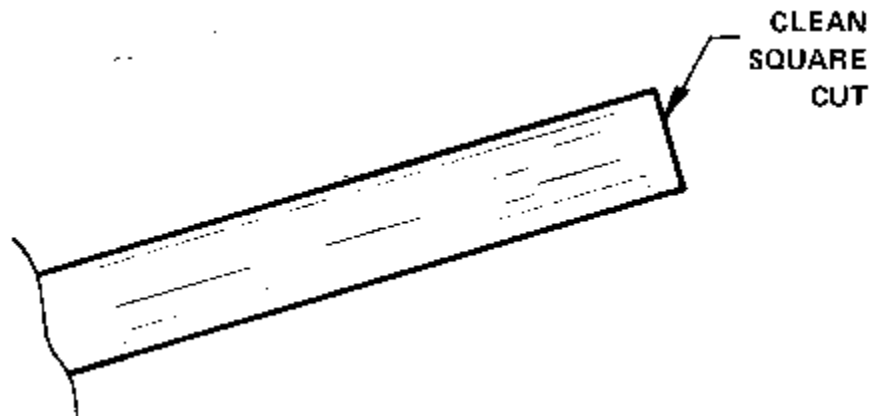

Figure 4

The ideal end is elusive because the hot melt synthetics, in particular, are plastic and cold flow under pressure. The knife deforms them somewhat. Some small amount of flattening is acceptable. Any end condition that tends to entangle another filament is not so acceptable. Some such end conditions are:

the finishing nail head, shown in Figure 5;

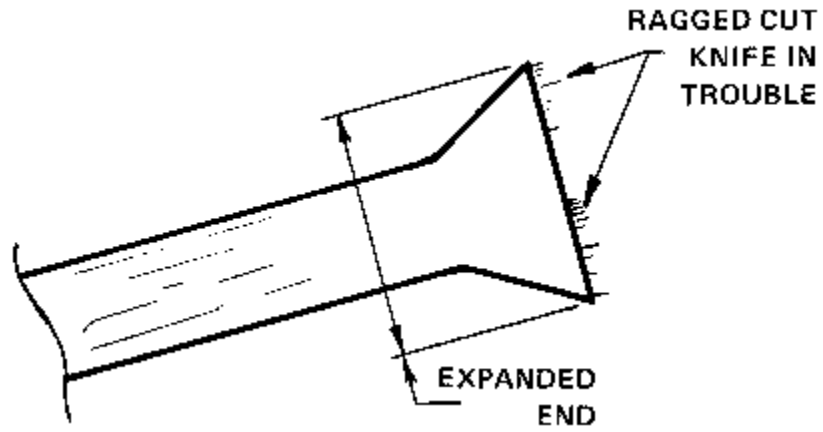

Figure 5

the elf shoe, shown in Figure 6;

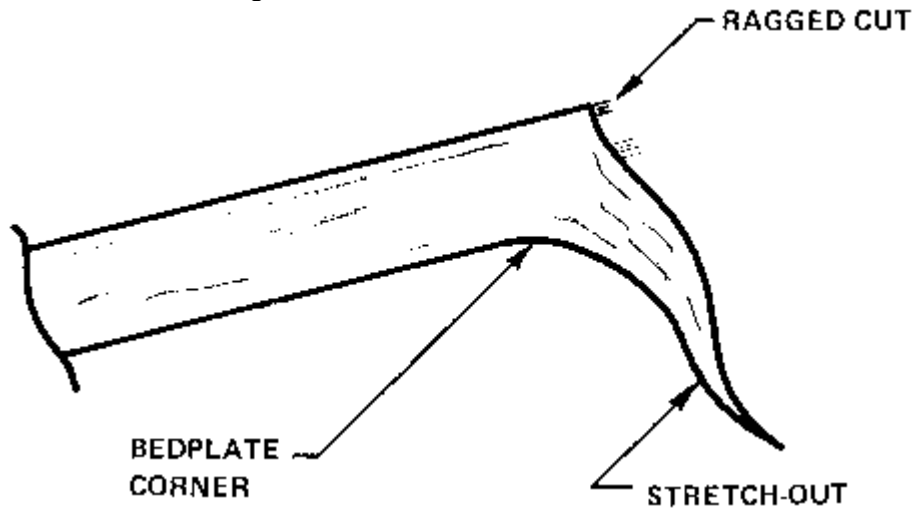

Figure 6

the split end, shown in Figure 7;

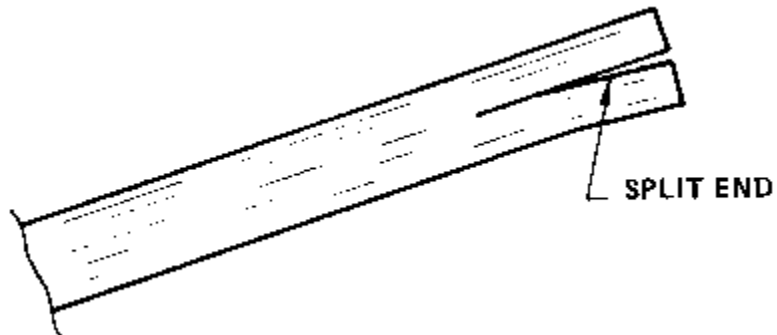

Figure 7

the fused ends, shown in Figure 8;

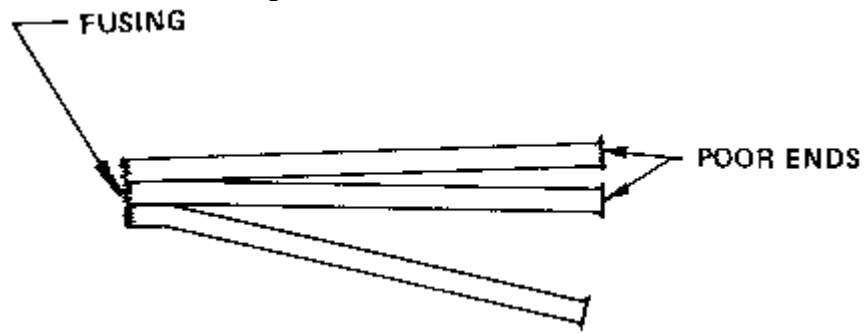

Figure 8

the fused log, shown in Figure 9;

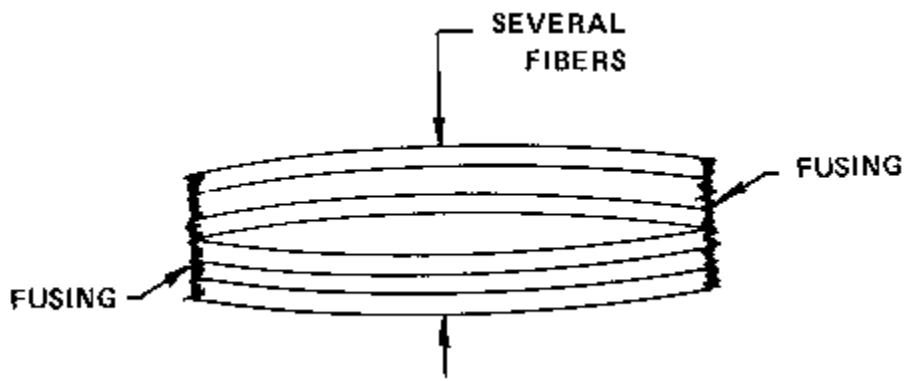

Figure 9

the fused daisy, shown in Figure 10,

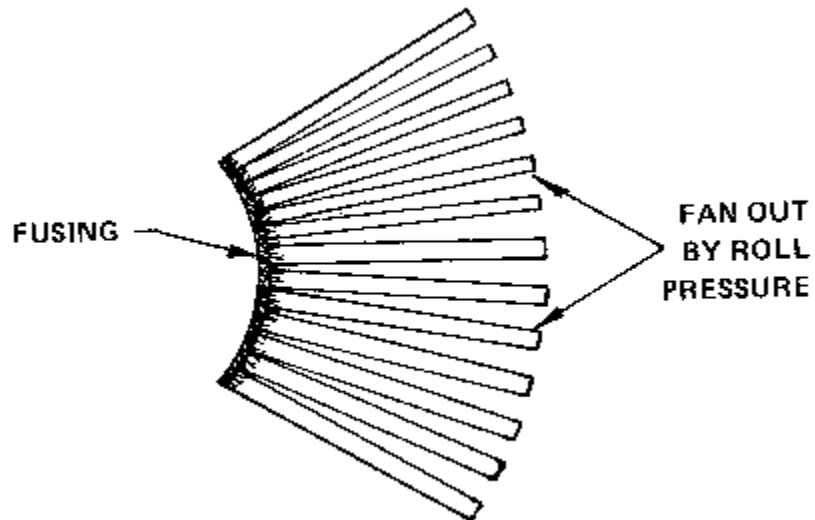
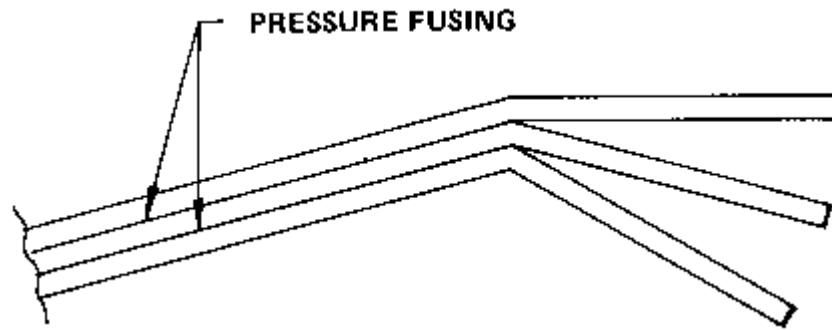

Figure 10

and pressure married fibers, shown in Figure 11.



**Figure 11**

It is heartening to note that some of these poor end conditions may go unnoticed, while running quite good web. This is especially true if they are not too prevalent and if they are not found in the company of extreme longs and/or fused filaments. Combinations in the same fiber stock usually spell trouble.

### **FIBER CUTTING THEORY**

Many mill people use the painful term “chop” for cut. The rate of severance in the cutting of fibers can be separated into two extremes. Common reptiles have been chosen to illustrate each: Fiber is cut quickly (chopped), like an alligator's snapping jaws; or fiber is cut slowly (sliced), like a boa constrictor's squeeze. The latter, because of the absence of plastic cold flow and heat generation, is much preferred. It produces the better cut. Though developments in fiber processing are constantly urging us to cut the fiber faster, the quality of such fiber is just as urgently telling us to cut fiber slower.

### **METHODS OF CUTTING FIBER**

With the general theory of the two extremes of timing established, there are presently five methods used in cutting fibers:

1. **Knife and bedplate:** See Figure 12. In this method, fiber is fed between rollers over a bedplate, and a rotating knife shears close beside the bedplate edge to cut the moving fiber. Several cutter types which espouse this oldest method of cutting are Taylor-Stiles, Peter Brotherhood, Pekrun, Mitsuishita, and Beria. Boy Scouts start fires by striking flints together; two pieces of hardened metal are little different. The disadvantages are impact (alligator) cut, multiple lengths, fluttering feed, and fused fibers.

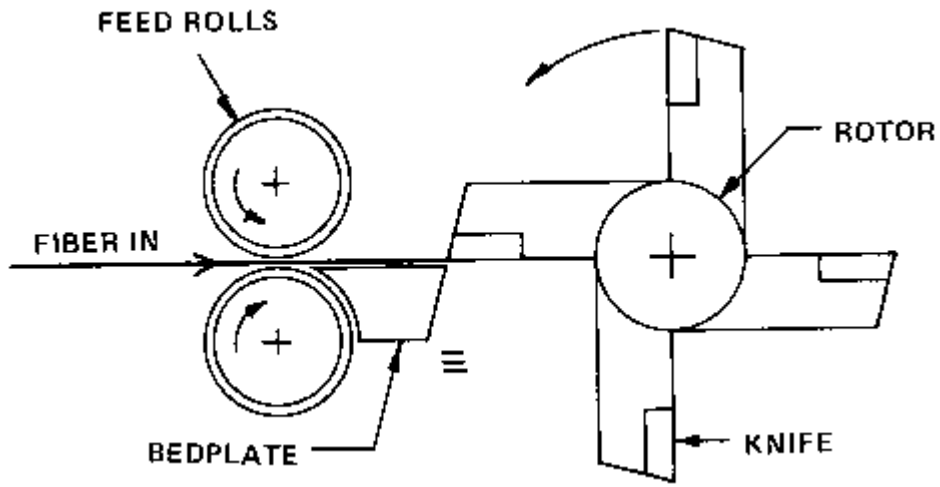

Figure 12

2. **Squeeze reels with knife slash through:** See Figure 13. In this method, two meshing rolls with rubber-covered fingers grip the fiber bundle on either side of the knife, while the knife is timed to slash between the moving fingers and cut the fiber. The Neumag (Gru-Gru) cutter is the only machine of this type. The design, interesting and unique, is used quite widely. The disadvantages are its impact (alligator) cut; down time to change knives (about every 30 minutes); the fact that it gets out of time and cuts rubber from the reel fingers; the fact that the knife hacks along on the filaments before cutting, damaging the filaments and dulling the knife; and its inability to cut short length staple.

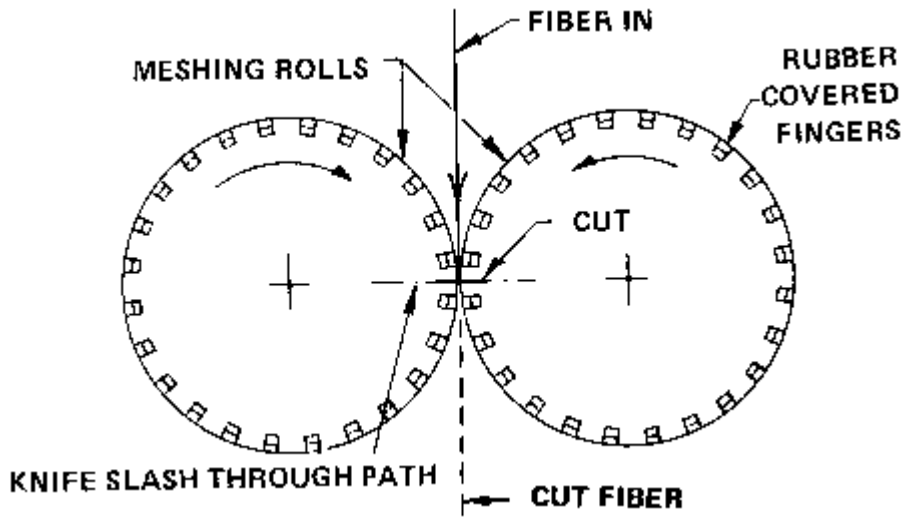

Figure 13

3. **Rubber covered squeeze rolls with protruding knives:** See Figure 14. In this method, two rolls form a pulling nip, with one roll having spaced knives protruding into the rubber covering on the other. This method is widely used to cut (fracture) glass fibers and some easily cut synthetics. The disadvantages are rapid dulling of knives, hence poor fiber end conditions; broken knives; double lengths (by embedding in rubber around edge of knife); and excessive noise and maintenance.

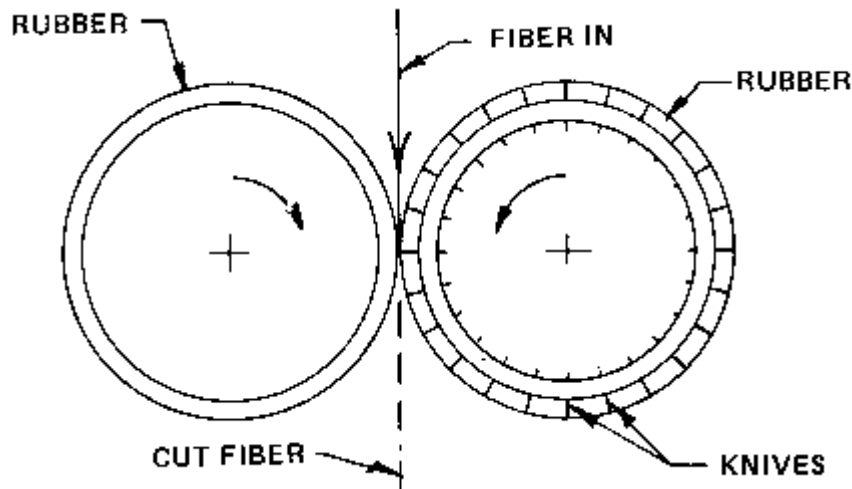

Figure 14

4. **Reel and roller:** See Figure 15. In this method, fiber is wrapped on a reel of knives, under tension, between two flanges. It is discouraged from building to a larger diameter by a rolling press wheel, thus forcing the fiber to be cut and pushed between the converging knives to escape. The Lummus cutter is the only machine of this type. First marketed in the late 1960's, it is now considered the standard of the long staple industry all over the world. It is a slow squeeze (boa constrictor) type cutter with many advantages, one being that nothing touches the edge of the knife except fiber. Some disadvantages are roping of output on long staple; blocking and stuffing on short staple; and because of this feature, inability to satisfactorily cut very short, wet lay staple.

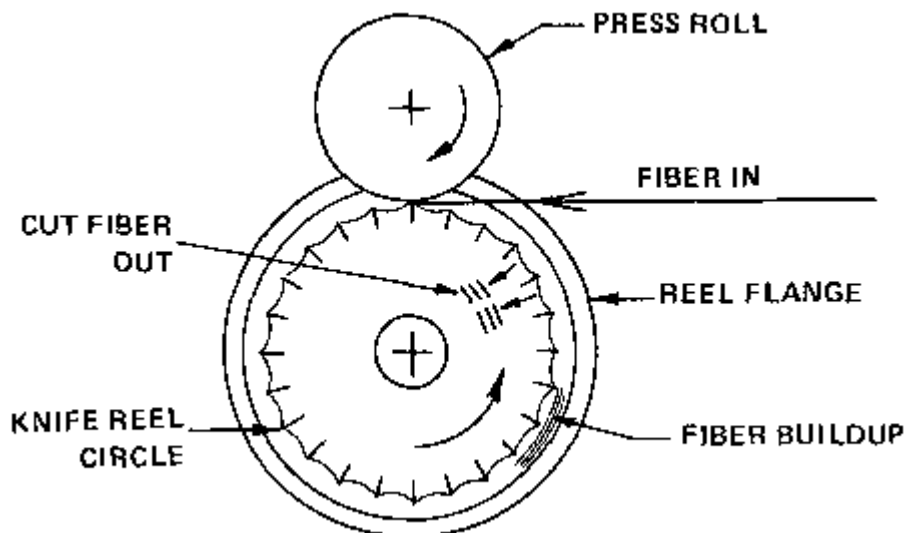

Figure 15



5. **Reel and cam:** See Figure 16. In this method, fiber is fed into the hollow of a cam to the interior of a sunburst of inwardly pointing knives. Fiber builds between the inner knife edges and the cam, and is forced outwardly to be cut and escape between the diverging knife surfaces. The original MiniFibers cutter was the first machine of this type. It was developed to avoid the stuffing and blocking problems found in the Lummus machine, and is best suited for cutting short staple for wet lay nonwoven use. The fiber does not stuff, because the escape slot is a diverging one and the cut fiber is free to escape without pressure. The machine is a slow squeeze (boa constrictor) type cutter with many advantages. Two disadvantages are frictional heat buildup on the fiber from the sliding cam action, and side thrust of the fiber against the knife.

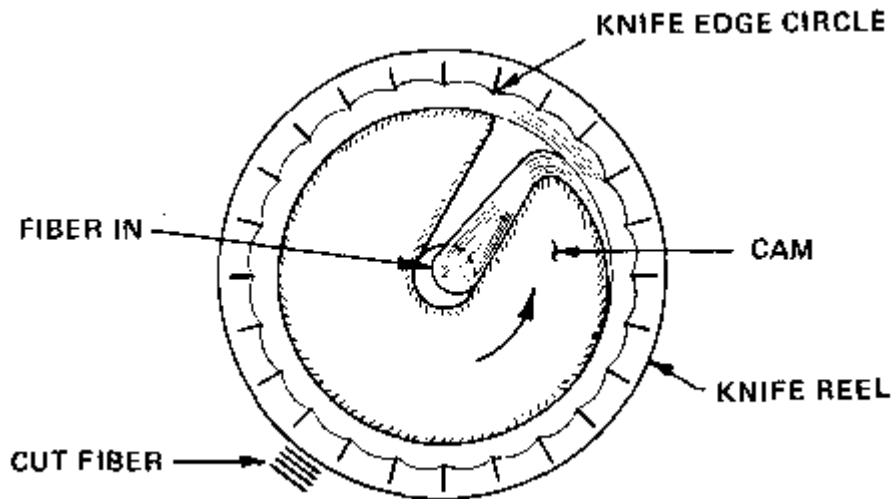

Figure 16

## SUMMARY

There is much work yet to be done. Let us develop better fiber cutting technology as a beginning; let us have the better machines to lay our webs; let us continue to develop and furnish new and exotic fibers; and let us hope for a combination of several developments which will ignite the nonwovens revolution and get it off the ground. Only then will the industry be able to upgrade to more demanding fabrics and demonstrate just how far it can go.

Precision Cut Fibers available from  
**MINIFIBERS, INC.**

2923 Boones Creek Road  
Johnson City, TN 37615  
Phone: (423) 282-4242  
Fax: (423) 282-1450  
[www.minifibers.com](http://www.minifibers.com)